LMJ Connectors

Threaded coupling circular connectors
designed to meet the requirements of
MIL-DTL-5015



Weald
ELECTRONICS

MANUFACTURERS OF HIGH QUALITY CONNECTORS AND CONNECTOR ACCESSORIES

www.wealdelectronics.com

**LMJ RANGE
CONTENTS**

Description and characteristics.....	3 - 4
Shell Styles	5 - 6
Ordering Information - Connectors	7
Ordering Information - Crimp Tooling	8
Ordering Information – Square Gaskets	8
Ordering Information - Protective Caps	9
Ordering Information – Cable Clamps	10
Ordering Information – Telescoping Bushing	10
Insert Configurations	11 -13
Contact Arrangements	
1, 2, 3, 4 Way	14
4, 5, 6, 7 Way	15
7, 8, 9, 10 Way	16
10, 11, 12, 13, 14, 16, 17, 19, 20 Way	17
22, 23, 24, 26, 27, 28, 30, 31, 35, 37, 42, 43, 47, 48, 52, 54, 85, 104 Way	18
Dimensions	19
Product Safety	20

About Weald Electronics

Weald Electronics is a leading U.K. manufacturer of electronic and electrical connectors for military and industrial interconnection applications specialising in high quality military circular connectors based on the MIL-DTL-5015 & MIL-DTL-26482 specification.

We offer a wide selection of circular bayonet coupling and screw coupling power connectors, filtered circular connectors and cable connectors in a wide choice of materials and finishes, with specialist ranges suited to the most demanding environments including mining & marine applications.

Customers may specify from a wide range of shell sizes, styles, plug and socket contact types and contact arrangements. Double sided bulkhead versions of our connectors are available and thermocouple contacts can be fitted on request.

Product Availability

Weald Electronics connectors are available through our sole worldwide distributors Lane Electronics.

Lane Electronics is a franchised distributor for Huber & Suhner, Souriau, ITW McMurdo, Pancon Connectors, Polamco, Glenair, AVX, Neutrik, Nicomatic, Positronic, Amphenol and HellermannTyton. Product types stocked include aerospace, coaxial, RF, audio, MIL-DTL-38999, DIN 41612, PCB, D type and back shells. This also includes Souriau's MIL-DTL-38999 Elio fibre optic, miniature and naval bronze connector types.

For all enquiries on price and availability, please contact Lane Electronics:

Phone: +44 (0)1403 790 661 - Direct line to the sales department.

Fax: +44 (0)1403 790 849

Email: sales@fclane.com



LMJ RANGE
DESCRIPTION AND CHARACTERISTICS

Weald Electronics LMJ Range connectors are designed to meet the operating requirements of MIL-DTL-5015 specification (the mainstay connector series of the Military and Aerospace Industry), as per JSS 50812 (equivalent to American MIL-C-5015) and are qualified by LCSC (Electronic Components Standards Organisation).

Featuring aluminium, threaded coupling shells with Polychloroprene / Neoprene inserts, LMJ connectors are available in 13 shell sizes and 10 shell styles, and with contact configurations from 1 to 104 pins. The LMJ range utilises silver plated, non-removable, solder contacts with an operating temperature range of -55°C to +125°C. Crimp and PCB tail contacts are available to order.

Originally designed for stringent military requirements, these high quality circular connectors are now widely used in industrial applications.

GENERAL SPECIFICATION

Shell housing	Aluminium Alloy to provide high mechanical strength while ensuring light weight.
Plating	Standard: Olive Drab Chromate Conversion Over Cadmium. Also available are RoHS compliant finishes Nickel, Zinc Nickel (Black), Zinc Cobalt (Black), Zinc Cobalt (Green).
Insulator material	Standard: Neoprene (synthetic) rubber, resistant to oils and fuels, dimensionally stable with high insulation resistance and dielectric strength under humidity and thermal stress. Options include Silicone, Viton and a flame-retardant halogen-free compound.
Contact material	Copper base alloy (other materials available)
Contact plating	Silver plated (other finishes available)
Mating cycle	500 couplings minimum
Operating temperature	-55°C to +125°C
Insulation resistance	Min. 5000 meg ohms at 500V DC
Current rating	10 to 150A (depends on contact arrangement)
Working voltage	200 to 3000V AC RMS (depends on contact arrangement)
Wire termination	Solder type (crimp and PCB version available to special order)
Sealing	Class F (Free / plug units) - Environmentally resistant with grommet seal, strain relief backshell and front 'O' ring seal. Class R (Fixed / receptacle units) - Environmentally resistant with panel seal. Class A (Free / plug units) - Environment resistant, without backshell and grommet seal and with front 'O' ring seal. Class E (Free / plug units) - Environmentally resistant with grommet seal, strain relief backshell and without front 'O' ring seal (not recommended for new equipment). Class EA – Environment resistant with removable A endbell adaptor and front 'O' ring seal.







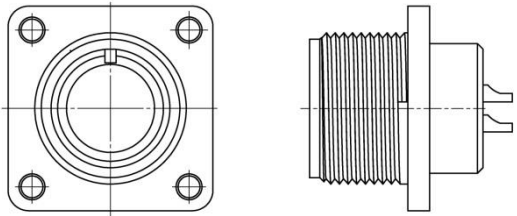

LMJ RANGE
DESCRIPTION AND CHARACTERISTICS

SERVICE RATING	INST	A	D	E	B	C
Test voltage at sea level AC (rms)	1000	2000	2800	3500	4500	7000
Rated working voltage DC at sea level AC (rms)	250	700	1250	1750	2450	4200
	200	500	900	1250	1750	3000
Effective Creepage (nom. mm)	1.57	3.18	4.75	6.35	7.92	25.4
Mechanical spacing (nom. mm)	-	1.57	3.18	4.75	6.35	7.92

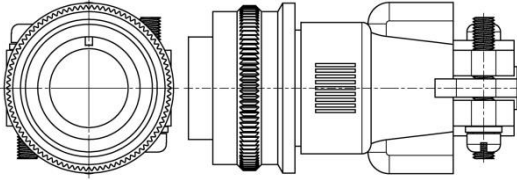
CONTACT SIZE	16	12	8	4	0
Max. test current (amps)	22	41	73	135	245
Rated current (amps)	13	23	46	80	150

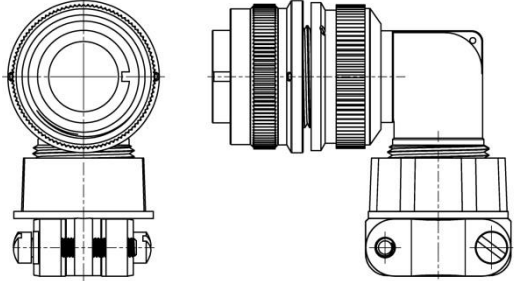

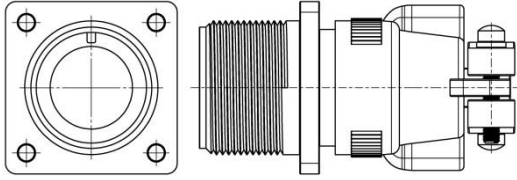

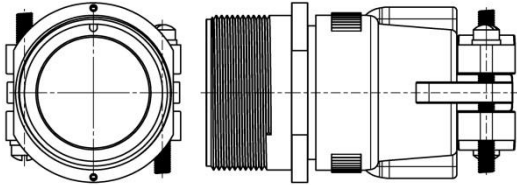

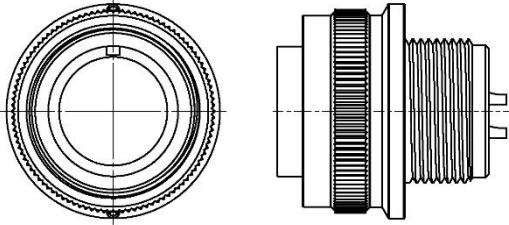

CONTACT SIZE	WIRE SIZE Dia. (mm)	OD OF INSULATED WIRE	
		Max. (mm)	Min. (mm)
16	0.80	3.30	1.63
	1.00		
	1.25		
12	1.60	4.32	2.90
	2.00		
8	2.50	6.48	4.17
	3.15		
4	4.00	9.40	6.90
	5.00		
0	6.30	13.98	10.55
	8.00		

**LMJ RANGE
SHELL STYLES**

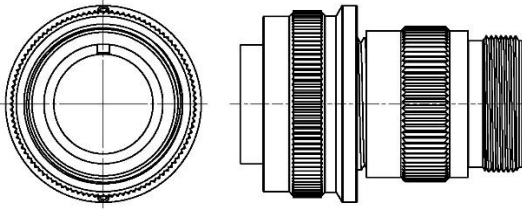
<p>LMJ 3102R FIXED UNIT (RECEPTACLE) BOX MOUNTING</p> <p>This unit is designed for panel mounting, using the four corner holes in the square flange.</p>			<p>Mates with: LMJ 3106 LMJ 3108 LMJ 3105</p>
<p>LMJ 3106F (E) FREE UNIT (PLUG) STRAIGHT</p> <p>This free unit is designed for cable mounting and is supplied with a removable cable clamp which provides excellent strain relief.</p>			<p>Mates with: LMJ 3100 LMJ 3101 LMJ 3102</p>
<p>LMJ 3108F (E) FREE UNIT (PLUG) 90°</p> <p>This free unit is designed for cable mounting and is supplied with a removable 90° outlet and cable clamp for wires and cables.</p>			<p>Mates with: LMJ 3100 LMJ 3101 LMJ 3102</p>
<p>LMJ 3100F (E) FIXED UNIT (RECEPTACLE) WALL MOUNTING</p> <p>This unit is designed for panel mounting, using the four corner holes in the square flange. It is supplied with a removable cable clamp which provides excellent strain relief.</p>			<p>Mates with: LMJ 3106 LMJ 3108 LMJ 3105</p>
<p>LMJ 3101F (E) CABLE COUPLER (RECEPTACLE)</p> <p>This unit is designed for use in conjunction with an LMJ 3106 unit when 'in line' cable to cable connection is required. It is supplied with a removable cable clamp which provides excellent strain relief.</p>			<p>Mates with: LMJ 3106 LMJ 3108 LMJ 3105</p>

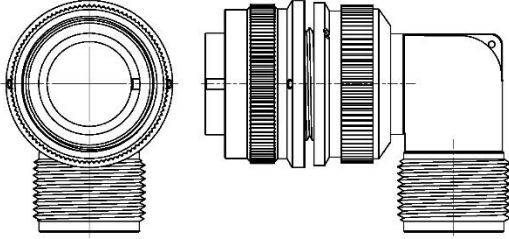
Note: LMJ 310*E versions (with lower environmental sealing perform.) can still be supplied, however for all new equipment, customers should specify LMJ 310*F.

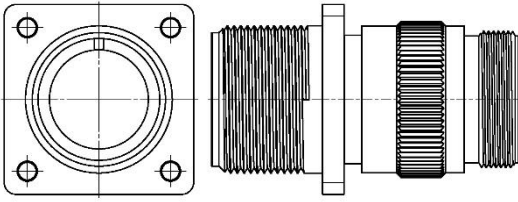
**LMJ RANGE
SHELL STYLES**

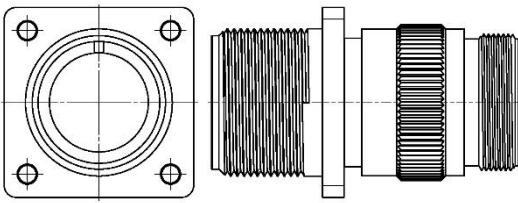
<p>LMJ 3105A FREE UNIT (PLUG) WITHOUT ACCESSORY</p> <p>This free unit is designed for cable mounting. It is supplied with accessory thread and without serration.</p>			<p>Mates with: LMJ 3100 LMJ 3101 LMJ 3102</p>
<p>LMJ 3106EA FREE UNIT (PLUG) STRAIGHT WITH A ENDBELL ADAPTOR</p> <p>This free unit is designed for cable mounting and is supplied with removable A endbell adaptor.</p>			<p>Mates with: LMJ 3100 LMJ 3101 LMJ 3102</p>
<p>LMJ 3108EA FREE UNIT (PLUG) 90° WITH A ENDBELL ADAPTOR</p> <p>This free unit is designed for cable mounting and is supplied with a removable 90° removable A endbell adaptor.</p>			<p>Mates with: LMJ 3100 LMJ 3101 LMJ 3102</p>
<p>LMJ 3100EA FIXED UNIT (RECEPTACLE) WALL MOUNTING</p> <p>This unit is designed for panel mounting, using the four corner holes in the square flange. It is supplied with removable A endbell adaptor.</p>			<p>Mates with: LMJ 3106 LMJ 3108 LMJ 3105</p>
<p>LMJ 3101EA CABLE COUPLER (RECEPTACLE)</p> <p>This unit is designed for use in conjunction with an LMJ 3106 unit when 'in line' cable to cable connection is required. It is supplied with removable A endbell adaptor.</p>			<p>Mates with: LMJ 3106 LMJ 3108 LMJ 3105</p>

Note: LMJ 310*E versions (with lower environmental sealing perform.) can still be supplied, however for all new equipment, customers should specify LMJ 310*F.

LMJ RANGE ORDERING INFORMATION

CONNECTORS

EXAMPLE LMJ 3102 R 28-21 S W GP XX

Range prefix

Shell style

3100 – Fixed unit (receptacle) wall mounting
3101 – Cable coupler (receptacle)
3102 – Fixed unit (receptacle) box mounting
3105 – Free unit (plug) without accessory
3106 – Free unit (plug) straight
3108 – Free unit (plug) 90° angle

Class

F – Environment resistant, with cable clamp, grommet seal and front 'O' ring for free units.
R – Environment resistant, for fixed unit (3102 only).
A – Environment resistant, without backshell and with front 'O' ring for free unit (3105 only).
EA – Environment resistant with removable A endbell adaptor and front 'O' ring for free units.
E – Environment resistant, with cable clamp, grommet seal and without front 'O' ring for free unit. Not recommended for new equipment.

Shell size

10SL, 12, 12S, 12SP, 14S, 14SL, 16, 16S, 18, 20, 20L, 22, 24, 24L, 28, 28L, 32, 32L, 32BL, 36, 36L, 40, 40BL, 44

Contact arrangement

Refer to pages [14 to 18](#)

Modification (omit for standard)

A30 – Crimp contacts, silver plated
C30 – Crimp contacts, flash gold plated, available in selected sizes (contact Sales Department for details)
211 – Less backshell grommet & follower
LC – Less contacts (crimp contacts only)
PMC – Pre mating contact
For other modification requirements contact Sales Department

Finish (omit for standard)

GP – Flash Gold plated contacts (solder)
NI – Bright Nickel plated
SS – Stainless Steel shell
101 – Zinc Cobalt Olive Drab RoHS comp.
003E – Zinc Cobalt Black RoHS compliant

Alternate insert position (omit for standard)

W, X, Y or Z for alternative position depending on insert.

Contact type

P – Pin (male contact)
S – Socket (female contact)

**LMJ RANGE
ORDERING INFORMATION**

CRIMP TOOLING

Weald LMJ Range of connectors is available with Crimp contacts in size 16 and 12.

Appropriate contacts are supplied loose with the connectors.

Weald Electronics recommends the use of Hand Crimp Tool with Contact Positioner (Locator), appropriate Insertion Tool, Extraction Tool and Guide/Pilot Pins.

Part numbers for all required tools as below.

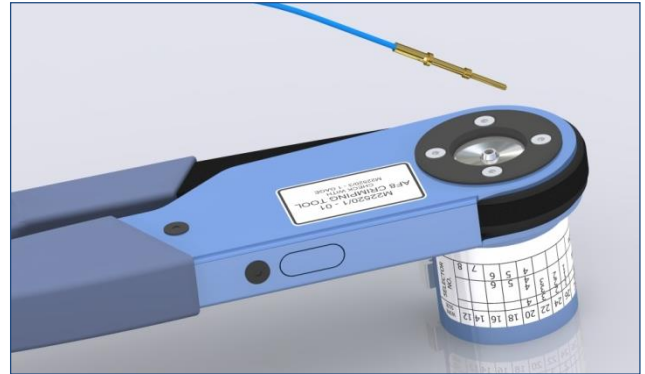

CONTACT SIZE	PILOT / GUIDE PIN FOR SOCKET INSERTION	HAND CRIMP TOOL	CONTACT POSITIONER	CONTACT INSERTION TOOL	CONTACT EXTRACTION TOOL
16	AEC16SCPLTPIN	M-22520/1-01	TH 29	AEC1612INSERT	AEC1612EXTRACT
12	AEC12SCPLTPIN				

Assembly instruction and spare contacts are available on request. Please contact Sales for more information.

SQUARE GASKETS

These sealing gaskets made of Neoprene are used with flange mounted receptacles (styles 3102R, 3100F/E and 3100EA).



PART NUMBER	FITS SHELL SIZE
LMJ 02-10 SQG	10
LMJ 02-12 SQG	12
LMJ 02-14 SQG	14
LMJ 02-16 SQG	16
LMJ 02-18 SQG	18
LMJ 02-20 SQG	20
LMJ 02-22 SQG	22
LMJ 02-24 SQG	24
LMJ 02-28 SQG	28
LMJ 02-32 SQG	32
LMJ 02-36 SQG	36
LMJ 02-40 SQG	40
LMJ 02-44 SQG	44

**LMJ RANGE
ORDERING INFORMATION**

PROTECTIVE CAPS

**PROTECTIVE METAL CAP LMA 25042
FOR 3105A, 3106 AND 3108 STYLES**



**PROTECTIVE METAL CAP LMA 25043
FOR 3100, 3101 AND 3102 STYLES**



These threaded metal dust caps are used to protect the mating faces of LMJ connectors. They are made from aluminium alloy and fitted with a stainless steel fixing chain.

PART NUMBER		FITS SHELL SIZE
FOR 3105A, 3106 AND 3108 STYLES	FOR 3100, 3101 AND 3102 STYLES	
LMA 25042-10D	LMA 25043-10D	10
LMA 25042-12D	LMA 25043-12D	12
LMA 25042-14D	LMA 25043-14D	14
LMA 25042-16D	LMA 25043-16D	16
LMA 25042-18D	LMA 25043-18D	18
LMA 25042-20D	LMA 25043-20D	20
LMA 25042-22D	LMA 25043-22D	22
LMA 25042-24D	LMA 25043-24D	24
LMA 25042-28D	LMA 25043-28D	28
LMA 25042-32D	LMA 25043-32D	32
LMA 25042-36D	LMA 25043-36D	36
LMA 25042-40D	LMA 25043-40D	40
LMA 25042-44D	LMA 25043-44D	44

**LMJ RANGE
ORDERING INFORMATION**

CABLE CLAMPS

The LMA3057A cable clamp is made for cable connector and receptacles that have an endbell with external conduit threads. The double clamping action provides a balanced, positive hold on the wires and greatly reduces moisture transmission. Provision is made for safety wiring. This clamp is supplied without bushing.



PART NUMBER	ACCOMODATES TELESCOPIC BUSHING	FITS SHELL SIZE
LMA3057-4A	LMA3420-4	10
LMA3057-4A	LMA3420-4	12
LMA3057-6A	LMA3420-6	14
LMA3057-8A	LMA3420-8	16
LMA3057-10A	LMA3420-10	18
LMA3057-12A	LMA3420-12	20
LMA3057-12A	LMA3420-12	22
LMA3057-16A	LMA3420-16, 12	24
LMA3057-16A	LMA3420-16, 12	28
LMA3057-20A	LMA3420-20, 16	32
LMA3057-24A	LMA3420-24, 20	36
LMA3057-28A	LMA3420-28, 24, 20	40

TELESCOPING BUSHING

Telescoping gland bushings (used with LMA3057A cable clamp) keeps dirt, oil and moisture out of endbell. Taping or wrapping wires is eliminated, since bushing protects wires going through clamp. Combinations of bushing may be used to decrease cable entry diameter to improve sealing. Material is Polychloroprene.



PART NUMBER	FITS SHELL SIZE
LMA3420-4	10
LMA3420-4	12
LMA3420-6	14
LMA3420-8	16
LMA3420-10	18
LMA3420-12	20
LMA3420-12	22
LMA3420-16	24
LMA3420-16	28
LMA3420-20	32
LMA3420-24	36
LMA3420-28	40

LMJ RANGE INSERT CONFIGURATIONS

SR. NO.	INSERT NO.	TOTAL CONTACTS	CONTACT SIZE					ALTERNATE INSERT POSITIONS** (DEGREES)			
			#0	#4	#8	#12	#16	W	X	Y	Z
1	10SL-3	3	-	-	-	-	3	-	-	-	-
2	10SL-4	2	-	-	-	-	2	-	-	-	-
3	12S-3	2	-	-	-	-	2	70	145	215	290
4	12-5*	1	-	-	-	1	-	-	-	-	-
5	12SP-10	4	-	-	-	-	4	-	-	-	-
6	14S-1	3	-	-	-	-	3	-	-	-	-
7	14S-2	4	-	-	-	-	4	-	120	240	-
8	14S-5	5	-	-	-	-	5	-	110	-	-
9	14S-6	6	-	-	-	-	6	-	-	-	-
10	14S-7	3	-	-	-	-	3	90	180	270	-
11	14S-9	2	-	-	-	-	2	70	145	215	290
12	14SL-61	7	-	-	-	-	7	-	-	-	-
13	16S-1	7	-	-	-	-	7	80	-	-	280
14	16S-4	2	-	-	-	-	2	35	110	250	325
15	16S-5	3	-	-	-	-	3	70	145	215	290
16	16S-8	5	-	-	-	-	5	-	170	265	-
17	16-9	4	-	-	-	2	2	35	110	250	325
18	16-10	3	-	-	-	3	-	90	180	270	-
19	16-11	2	-	-	-	2	-	35	110	250	325
20	16-12	1	-	1	-	-	-	-	-	-	-
21	18-1	10	-	-	-	-	10	70	145	215	290
22	18-3	2	-	-	-	2	-	35	110	250	325
23	18-4	4	-	-	-	-	4	35	110	250	325
24	18-5	3	-	-	-	2	1	80	110	250	280
25	18-8	8	-	-	-	1	7	70	-	-	290
26	18-9	7	-	-	-	2	5	80	110	250	280
27	18-10	4	-	-	-	4	-	-	120	240	-
28	18-11	5	-	-	-	5	-	-	170	265	-
29	18-12	6	-	-	-	-	6	80	-	-	280
30	18-16	1	-	-	-	1	-	-	-	-	-
31	18-19	10	-	-	-	-	10	-	-	-	-
32	18-20	5	-	-	-	-	5	90	180	270	-
33	20-2	1	1	-	-	-	-	-	-	-	-
34	20-3	3	-	-	-	3	-	70	145	215	290
35	20-4	4	-	-	-	4	-	45	110	250	-
36	20-7	8	-	-	-	-	8	80	110	250	280
37	20-8	6	-	-	2	-	4	80	110	250	280
38	20L-9	9	-	-	-	9	-	-	110	250	-
39	20-11	13	-	-	-	-	13	-	-	-	-
40	20-14	5	-	-	2	3	-	80	110	250	280
41	20-15	7	-	-	-	7	-	80	-	-	280
42	20-16	9	-	-	-	2	7	80	110	250	280
43	20-17	6	-	-	-	5	1	90	180	270	-
44	20-18	9	-	-	-	3	6	35	110	250	325

** ALTERNATE POSITIONS: To avoid mis-mating of similar connectors which may be adjacently mounted, polarisation is achieved with different angular positioning of the insulator within the shell. On the right of the table above is a list of different angular positions for various contact arrangements. Viewed on the front face, plug (male) inserts rotate clockwise, and sockets (female) rotate anti-clockwise.

* Contact Weald Electronics before ordering (non preferred range).

**LMJ RANGE
INSERT CONFIGURATIONS**

SR. NO.	INSERT NO.	TOTAL CONTACTS	CONTACT SIZE					ALTERNATE INSERT POSITIONS** (DEGREES)			
			#0	#4	#8	#12	#16	W	X	Y	Z
45	20-19	3	-	-	3	-	-	90	180	270	-
46	20-21	9	-	-	-	1	8	35	110	250	325
47	20-22	6	-	-	3	-	3	80	110	250	280
48	20-23	2	-	-	2	-	-	35	110	250	325
49	20-24	4	-	-	2	-	2	35	110	250	325
50	20-27	14	-	-	-	-	14	35	110	250	325
51	20-29	17	-	-	-	-	17	80	-	-	280
52	20-33	11	-	-	-	-	11	-	-	-	-
53	20L-48	19	-	-	-	-	19	-	80	280	-
54	22-2	3	-	-	3	-	-	70	145	215	290
55	22-5	6	-	-	-	2	4	35	110	250	325
56	22-7	1	1	-	-	-	-	-	-	-	-
57	22-9	3	-	-	-	3	-	70	145	215	290
58	22-10	4	-	-	-	-	4	35	110	250	325
59	22-11	2	-	-	-	-	2	35	110	250	325
60	22-14	19	-	-	-	-	19	80	110	250	280
61	22-15	6	-	-	-	5	1	80	110	250	280
62	22-16	9	-	-	-	3	6	80	110	250	280
63	22-18	8	-	-	-	-	8	80	110	250	280
64	22-19	14	-	-	-	-	14	80	110	250	280
65	22-20	9	-	-	-	-	9	35	110	250	325
66	22-22	4	-	-	4	-	-	-	110	250	-
67	22-23	8	-	-	-	8	-	35	-	250	-
68	22-28	7	-	-	-	7	-	80	-	-	250
69	22-29	7	-	1	-	-	6	80	110	250	280
70	22-33	7	-	-	-	-	7	80	110	250	280
71	22-34	5	-	-	-	3	2	80	110	250	280
72	24-2	7	-	-	-	7	-	80	-	-	280
73	24-4	4	1	-	-	-	3	80	110	250	280
74	24-5	16	-	-	-	-	16	80	110	250	280
75	24-6	8	-	-	-	8	-	80	110	250	280
76	24-7	16	-	-	-	2	14	80	110	250	280
77	24-9	2	-	2	-	-	-	35	110	250	325
78	24-10	7	-	-	7	-	-	80	-	-	280
79	24-11	9	-	-	3	6	-	35	110	250	325
80	24-12	5	-	2	-	3	-	80	110	250	280
81	24-20	11	-	-	-	2	9	80	110	250	280
82	24-21	10	-	-	1	-	9	80	110	250	280
83	24-22	4	-	-	4	-	-	45	110	250	-
84	24-27	7	-	-	-	-	7	80	-	-	280
85	24-28	24	-	-	-	-	24	80	110	250	280
86	24L-58*	13	-	-	3	3	7	-	-	-	-
87	28-3	3	-	-	3	-	-	70	145	215	290
88	28-5	5	-	2	-	1	2	35	110	250	325
89	28-6	3	-	3	-	-	-	70	145	215	290

** ALTERNATE POSITIONS: To avoid mis-mating of similar connectors which may be adjacently mounted, polarisation is achieved with different angular positioning of the insulator within the shell. On the right of the table above is a list of different angular positions for various contact arrangements. Viewed on the front face, plug (male) inserts rotate clockwise, and sockets (female) rotate anti-clockwise.

* Contact Weald Electronics before ordering (non preferred range).

**LMJ RANGE
INSERT CONFIGURATIONS**

SR. NO.	INSERT NO.	TOTAL CONTACTS	CONTACT SIZE					ALTERNATE INSERT POSITIONS** (DEGREES)			
			#0	#4	#8	#12	#16	W	X	Y	Z
90	28-8	12	-	-	-	2	10	80	110	250	280
91	28-9	12	-	-	-	6	6	80	110	250	280
92	28-10	7	-	2	2	3	-	80	110	250	280
93	28-11	22	-	-	-	4	18	80	110	250	280
94	28-12	26	-	-	-	-	26	90	180	270	-
95	28-13	26	-	-	-	-	26	-	-	-	-
96	28-15	35	-	-	-	-	35	80	110	250	280
97	28-16	20	-	-	-	-	20	80	110	250	280
98	28L-16	9	-	4	-	-	5	-	-	-	-
99	28-18	12	-	-	-	-	12	70	145	215	290
100	28-19	10	-	-	-	4	6	80	110	250	280
101	28-20	14	-	-	-	10	4	80	110	250	280
102	28-21	37	-	-	-	-	37	80	110	250	280
103	28-22	6	-	3	-	-	3	70	145	215	290
104	28-51*	12	-	-	-	12	-	-	-	195	-
105	28L-51	43	-	-	-	-	43	-	-	-	-
106	28L-61	16	-	-	-	16	-	-	-	-	-
107	28L-63	28	-	-	-	9	19	-	100	260	-
108	32-3	9	1	2	-	2	4	80	110	250	280
109	32-4	14	-	-	-	2	12	80	110	250	280
110	32-5	2	2	-	-	-	-	35	110	250	325
111	32-6	23	-	2	3	2	16	80	110	250	280
112	32-7	35	-	-	-	7	28	80	125	235	280
113	32-8	30	-	-	-	6	24	80	125	235	280
114	32-9	14	-	2	-	-	12	80	110	250	280
115	32L-10	54	-	-	-	-	54	-	-	-	-
116	32BL-13*	13	-	-	-	13	-	65	130	230	295
117	32-15	8	2	-	-	6	-	35	110	250	280
118	32-17	4	-	4	-	-	-	45	110	250	-
119	32L-50	5	-	5	-	-	-	-	-	-	-
120	32L-68	16	-	4	-	-	12	-	-	-	-
121	36-5	4	4	-	-	-	-	-	120	240	-
122	36-9	31	-	1	2	14	14	80	125	235	280
123	36-10	48	-	-	-	-	48	80	125	235	280
124	36-14	16	-	-	5	5	6	90	180	270	-
125	36-15	35	-	-	-	-	35	60	125	245	305
126	36L-34	52	-	-	-	-	52	-	-	-	-
127	36L-46	27	-	-	-	27	-	-	-	-	-
128	36-52	52	-	-	-	-	52	72	144	216	288
129	40-1	30	-	-	-	6	24	65	130	235	300
130	40-9	47	-	-	1	22	24	65	125	225	310
131	40BL-35*	35	-	-	-	35	-	70	130	230	290
132	40-56	85	-	-	-	-	85	72	144	216	288
133	44-1	42	-	-	-	6	36	65	125	225	310
134	44-52	104	-	-	-	-	104	-	-	-	-

** ALTERNATE POSITIONS: To avoid mis-mating of similar connectors which may be adjacently mounted, polarisation is achieved with different angular positioning of the insulator within the shell. On the right of the table above is a list of different angular positions for various contact arrangements. Viewed on the front face, plug (male) inserts rotate clockwise, and sockets (female) rotate anti-clockwise.

* Contact Weald Electronics before ordering (non preferred range).

LMJ RANGE CONTACT ARRANGEMENTS

1



ARRANGEMENT	12-5*	16-12	18-16	20-2	22-7	10SL-4
NO. OF CONTACTS	1	1	1	1	1	2
CONTACT SIZE	12	4	12	0	0	16
SERVICE RATING	D	A	C	D	E	A

2

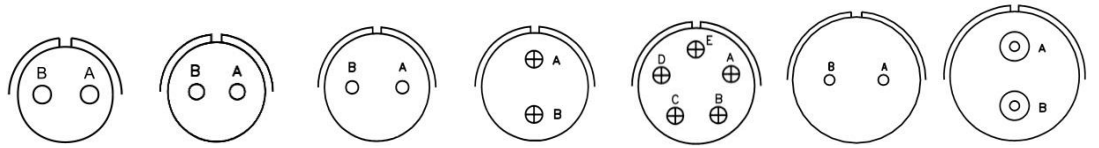

ARRANGEMENT	12S-3	14S-9	16S-4	16-11	18-3	22-11	20-23
NO. OF CONTACTS	2	2	2	2	2	2	2
CONTACT SIZE	16	16	16	12	12	16	8
SERVICE RATING	A	A	D	A	D	B	A

3

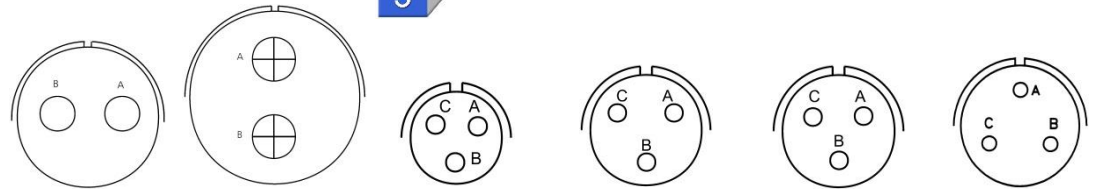

ARRANGEMENT	24-9	32-5	10SL-3	14S-1	14S-7	16S-5
NO. OF CONTACTS	2	2	3	3	3	3
CONTACT SIZE	4	0	16	16	16	16
SERVICE RATING	A	D	A	A	A	A

3

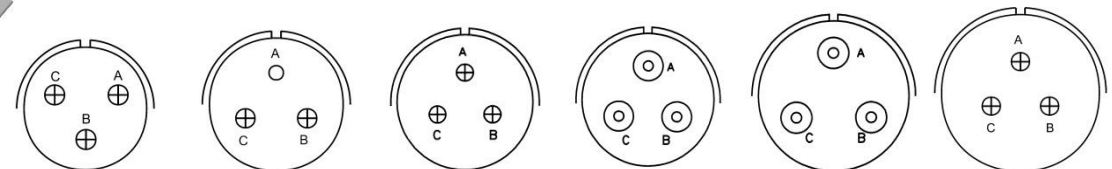

ARRANGEMENT	16-10	18-5	20-3	20-19	22-2	22-9
NO. OF CONTACTS	3	3	3	3	3	3
CONTACT SIZE	12	2-12, 1-16	12	8	8	12
SERVICE RATING	A	D	D	A	D	E

3

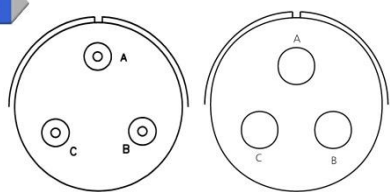

4

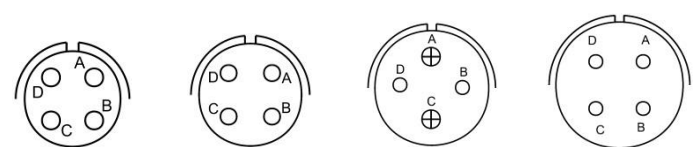

ARRANGEMENT	28-3	28-6	12SP-10	14S-2	16-9	18-4
NO. OF CONTACTS	3	3	4	4	4	4
CONTACT SIZE	8	4	16	16	2-12, 2-16	16
SERVICE RATING	E	D	INST	INST	A	D



* Contact Weald Electronics before ordering (non preferred range).

LMJ RANGE CONTACT ARRANGEMENTS

4

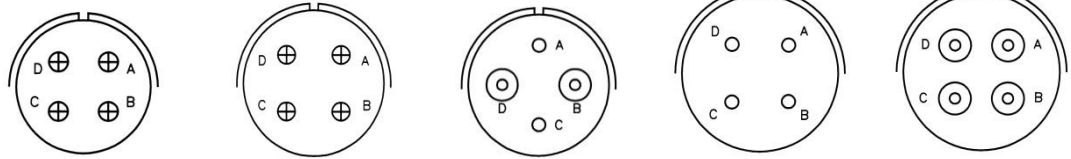

ARRANGEMENT	18-10	20-4	20-24	22-10	22-22
NO. OF CONTACTS	4	4	4	4	4
CONTACT SIZE	12	12	2-8, 2-16	16	8
SERVICE RATING	A	D	A	E	A

4

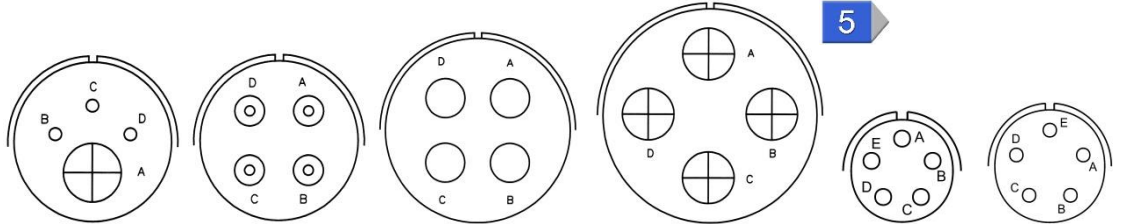

5

ARRANGEMENT	24-4	24-22	32-17	36-5	14S-5	16S-8
NO. OF CONTACTS	4	4	4	4	5	5
CONTACT SIZE	1-0, 3-16	8	4	0	16	16
SERVICE RATING	D	D	D	A	INST	A

5

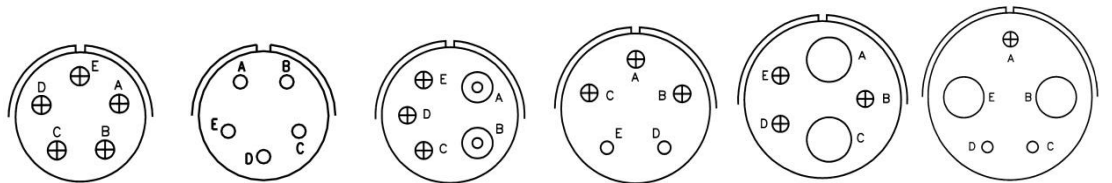

ARRANGEMENT	18-11	18-20	20-14	22-34	24-12	28-5
NO. OF CONTACTS	5	5	5	5	5	5
CONTACT SIZE	12	16	2-8, 3-12	3-12, 2-16	2-4, 3-12	2-4, 1-12, 2-16
SERVICE RATING	A	A	A	D	A	D

5

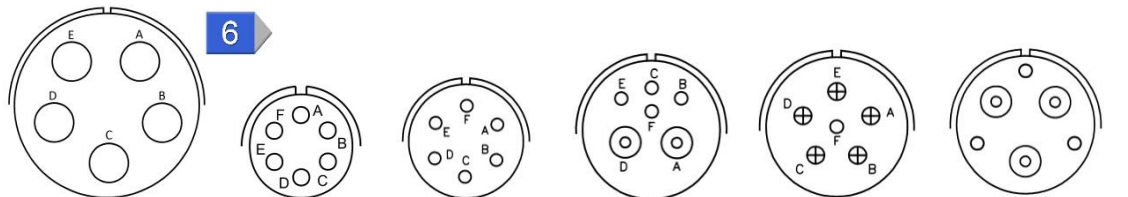

6

ARRANGEMENT	32L-50	14S-6	18-12	20-8	20-17	20-22
NO. OF CONTACTS	5	6	6	6	6	6
CONTACT SIZE	4	16	16	2-8, 4-16	5-12, 1-16	3-8, 3-16
SERVICE RATING	D	INST	A	INST	A	A

6

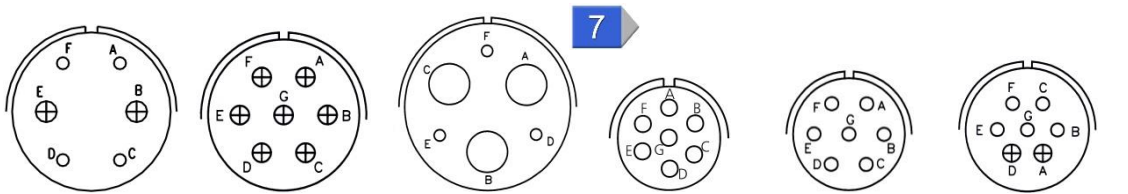

7

ARRANGEMENT	22-5	22-15	28-22	14SL-61	16S-1	18-9
NO. OF CONTACTS	6	6	6	7	7	7
CONTACT SIZE	2-12, 4-16	5-12, 1-16	3-4, 3-16	16	16	2-12, 5-16
SERVICE RATING	D	D=E, ABCEF=A	D	INST	A	INST

CONTACT LEGEND	16 ○	12 ⊕	8 ⊙	4 ○	0 ⊕
----------------	------	------	-----	-----	-----

* Contact Weald Electronics before ordering (non preferred range).

LMJ RANGE CONTACT ARRANGEMENTS

7

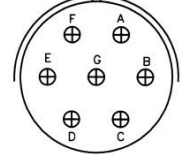
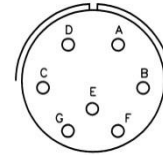
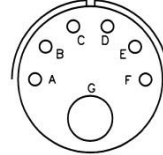
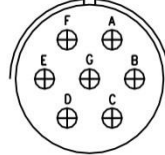
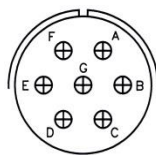

ARRANGEMENT	20-15	22-28	22-29	22-33	24-2
NO. OF CONTACTS	7	7	7	7	7
CONTACT SIZE	12	12	1-4, 6-16	16	12
SERVICE RATING	A	A	A	ABCD=D, EFG=A	D

7

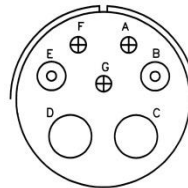
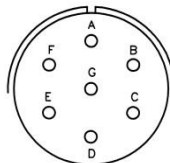
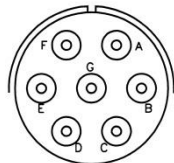

8

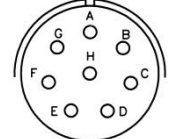
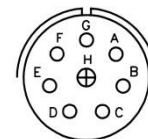

ARRANGEMENT	24-10	24-27	28-10	18-8	20-7
NO. OF CONTACTS	7	7	7	8	8
CONTACT SIZE	8	16	2-4, 2-8, 3-12	1-12, 7-16	16
SERVICE RATING	A	E	G=D, BAL=A	A	ABHG=D, CDEF=A

8

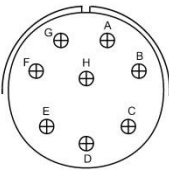
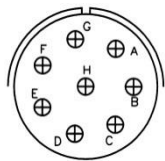
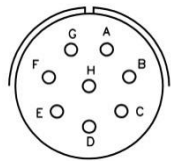

8

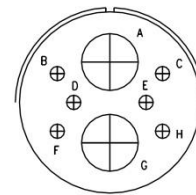

9

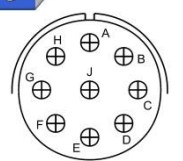

ARRANGEMENT	22-18	22-23	24-6	32-15	20L-9
NO. OF CONTACTS	8	8	8	8	9
CONTACT SIZE	16	12	12	2-0, 6-12	12
SERVICE RATING	ABFGH=D, CDE=A	H=D, BAL=A	AGH=D, BAL=A	D	INST

9

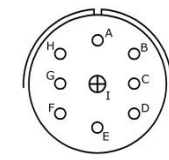
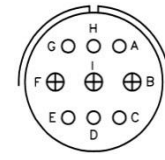
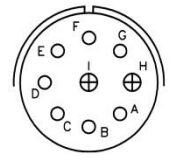

9

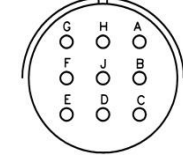
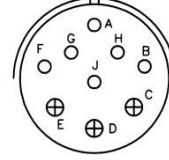

ARRANGEMENT	20-16	20-18	20-21	22-16	22-20
NO. OF CONTACTS	9	9	9	9	9
CONTACT SIZE	2-12, 7-16	3-12, 6-16	1-12, 8-16	3-12, 6-16	16
SERVICE RATING	A	A	A	A	A

9

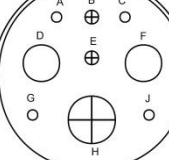
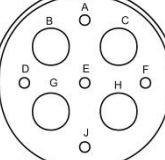
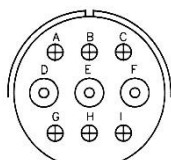

10

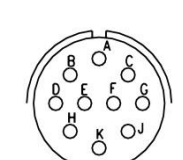
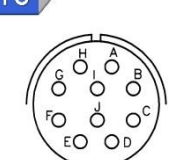

ARRANGEMENT	24-11	28L-16	32-3	18-1	18-19
NO. OF CONTACTS	9	9	9	10	10
CONTACT SIZE	3-8, 6-12	5-16, 4-4	4-16, 2-12, 2-4, 1-0	16	16
SERVICE RATING	A	A	D	BCFG=A, BAL=INST	A

CONTACT LEGEND	16 ○	12 ⊕	8 ⊙	4 ⊖	0 ⊕
----------------	------	------	-----	-----	-----

* Contact Weald Electronics before ordering (non preferred range).

LMJ RANGE CONTACT ARRANGEMENTS

10

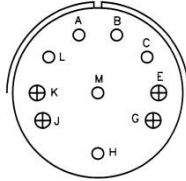
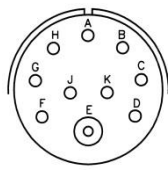

11

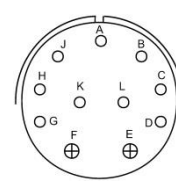
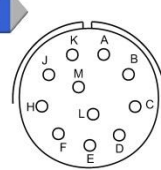

12

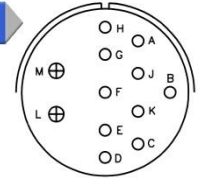

ARRANGEMENT	24-21	28-19	20-33	24-20	28-8
NO. OF CONTACTS	10	10	11	11	12
CONTACT SIZE	1-8, 9-16	4-12, 6-16	16	9-16, 2-12	2-12, 10-16
SERVICE RATING	D	HM=E, B=D, BAL=A	A	D	LM=E, B=D, BAL=A

12

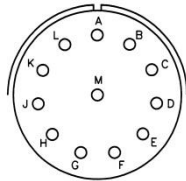
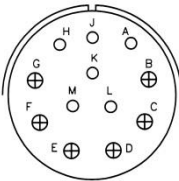

13

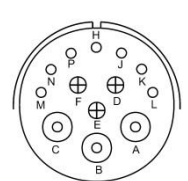
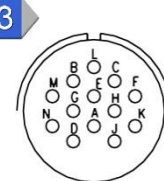
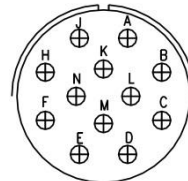

ARRANGEMENT	28-9	28-18	28-51*	20-11	24L-58*
NO. OF CONTACTS	12	12	12	13	13
CONTACT SIZE	6-12, 6-16	16	12	16	3-8, 3-12, 7-16
SERVICE RATING	D	M=C, GHJKL=D, AB=A, BAL=INST	A	INST	INST

13

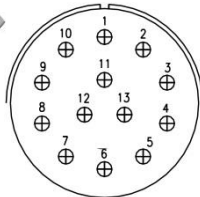

14

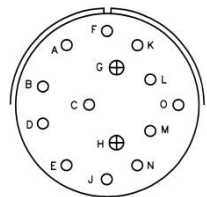
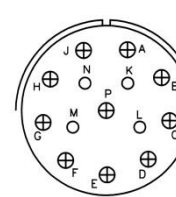
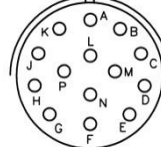
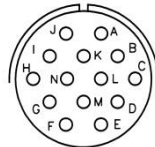

ARRANGEMENT	32BL-13*	20-27	22-19	28-20	32-4
NO. OF CONTACTS	13	14	14	14	14
CONTACT SIZE	12	16	16	10-12, 4-16	2-12, 12-16
SERVICE RATING	D	A	A	A	FJKN=A, BAL=D

14

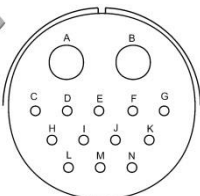

16

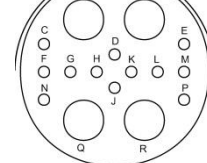
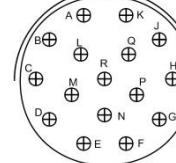
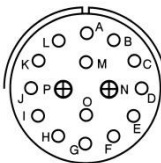
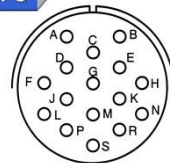

ARRANGEMENT	32-9	24-5	24-7	28L-61	32L-68
NO. OF CONTACTS	14	16	16	16	16
CONTACT SIZE	12-16, 2-4	16	2-12, 14-16	12	4-4, 12-16
SERVICE RATING	D	A	A	A	A

16

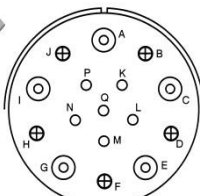

17

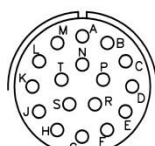

19

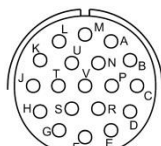

20

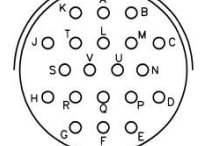

ARRANGEMENT	36-14	20-29	20L-48	22-14	28-16
NO. OF CONTACTS	16	17	19	19	20
CONTACT SIZE	5-8, 5-12, 6-16	16	16	16	16
SERVICE RATING	D	A	INST	A	A

CONTACT LEGEND 16 ○ 12 ⊕ 8 ⊙ 4 ○ 0 ⊕

* Contact Weald Electronics before ordering (non preferred range).

LMJ RANGE CONTACT ARRANGEMENTS

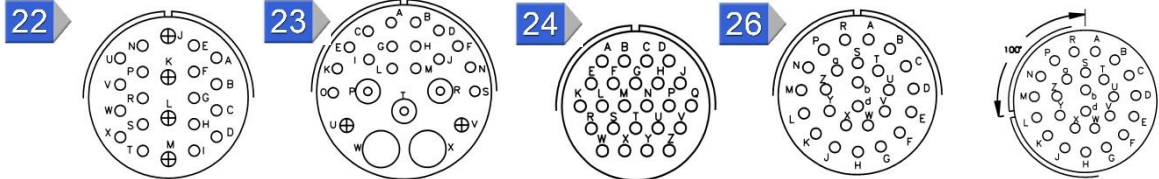

ARRANGEMENT	28-11	32-6	24-28	28-12	28-13
NO. OF CONTACTS	22	23	24	26	26
CONTACT SIZE	4-12, 18-16	2-4, 3-8, 2-12, 16-16	16	16	16
SERVICE RATING	A	A	INST	A	A

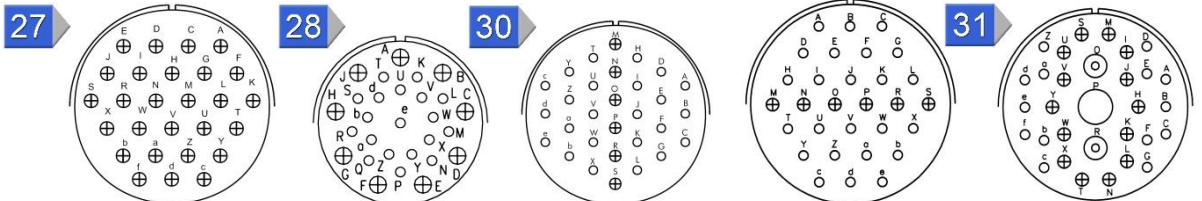

ARRANGEMENT	36L-46	28L-63	32-8	40-1	36-9
NO. OF CONTACTS	27	28	30	30	31
CONTACT SIZE	12	9-12, 19-16	6-12, 24-16	6-12, 24-16	1-4, 2-8, 14-12, 14-16
SERVICE RATING	A	A=e, BAL=INST	A	D	A

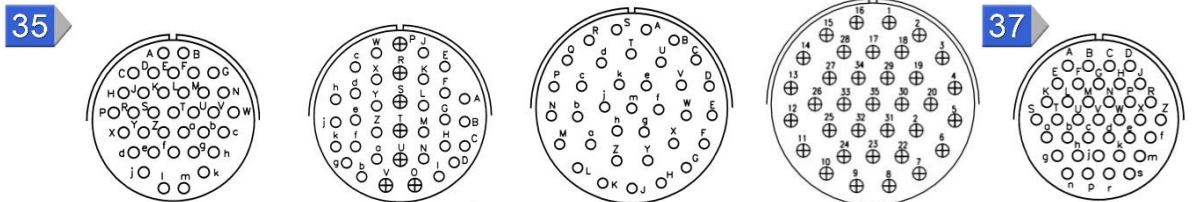

ARRANGEMENT	28-15	32-7	36-15	40BL-35*	28-21
NO. OF CONTACTS	35	35	35	35	37
CONTACT SIZE	16	7-12, 28-16	16	12	16
SERVICE RATING	A	ABHi=INST, BAL=A	m=D, BAL=A	D	A

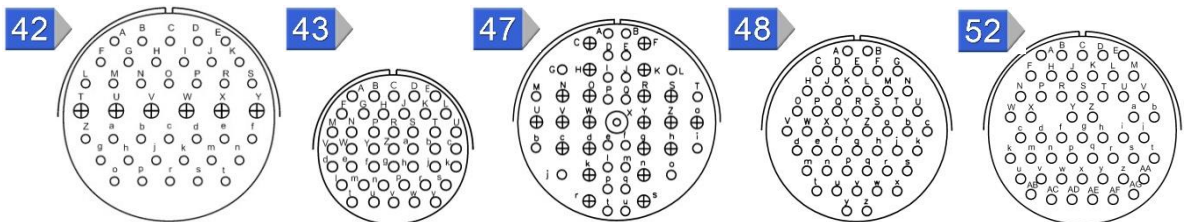

ARRANGEMENT	44-1	28L-51	40-9	36-10	36L-34
NO. OF CONTACTS	42	43	47	48	52
CONTACT SIZE	6-12, 36-16	16	1-8, 22-12, 24-16	16	16
SERVICE RATING	D	A	A	A	A

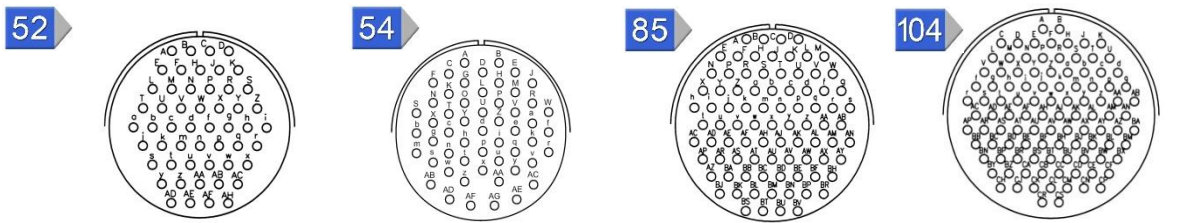

ARRANGEMENT	36-52	32L-10	40-56	44-52
NO. OF CONTACTS	52	54	85	104
CONTACT SIZE	16	16	16	16
SERVICE RATING	A	A	A	A

CONTACT LEGEND 16 ○ 12 ⊕ 8 ⊙ 4 ○ 0 ⊕

* Contact Weald Electronics before ordering (non preferred range).

LMJ RANGE DIMENSIONS

LMJ 3100F FIXED UNIT WALL MOUNTING

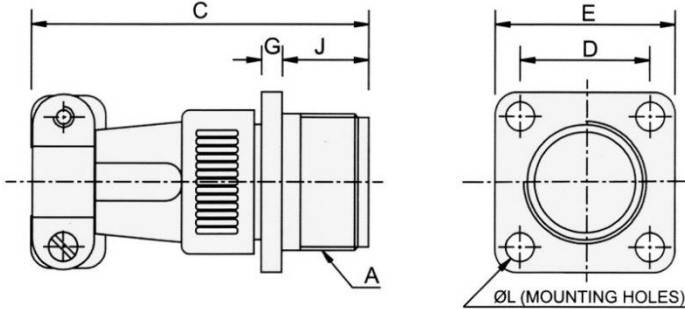

LMJ 3101F CABLE COUPLER FREE UNIT

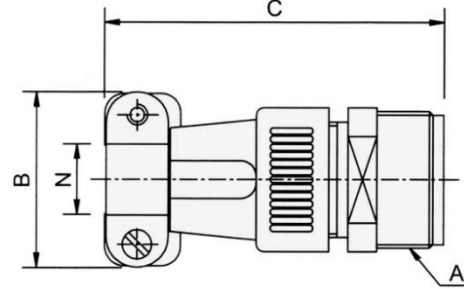

LMJ 3102R FIXED UNIT BOX MOUNTING

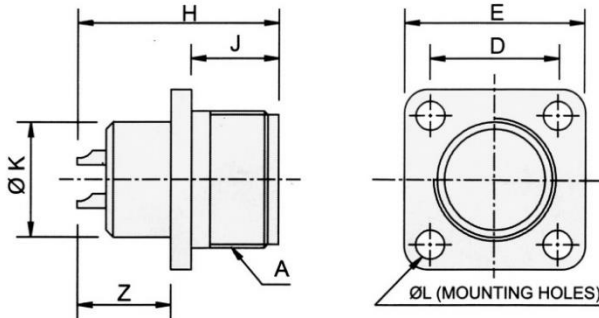

LMJ 3106F FREE UNIT STRAIGHT

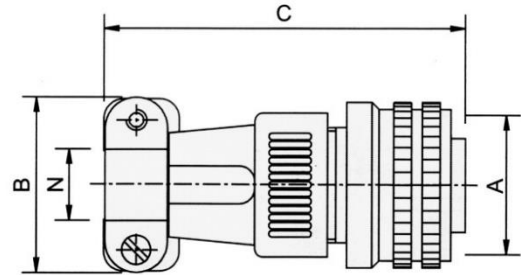

LMJ 3108F FREE UNIT 90 DEGREE ANGLE

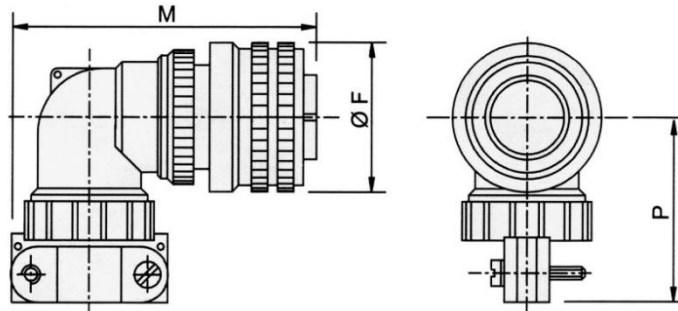

SHELL SIZE	A THREADING	B MAX	C MAX	D ±0.13	E-SQ. ±0.79	ØF MAX	G MAX	H MAX	J +0.79 -0.00	ØK ±0.30	ØL +0.25 -0.13	M MAX	N MIN MAX	P MAX	Z
10SL	5/8" - 24 UNEF	23.00	57.15	18.26	25.40	24.59	3.96	30.18	14.27	15.40	3.05	55.58	3.60 7.50	38.10	13.15 to 19.50 depending upon contact gauges and shell size
12S	3/4" - 20 UNEF	23.00	57.15	20.62	27.79	26.97	3.96	30.18	14.27	15.90	3.05	55.58	3.60 7.50	38.10	
14S	7/8" - 20 UNEF	28.00	57.15	23.01	30.18	29.36	3.96	30.18	14.27	19.00	3.05	58.72	5.00 10.70	40.49	
16S	1" - 20 UNEF	30.50	57.15	24.61	32.54	31.75	3.96	31.08	14.27	22.30	3.05	61.11	6.50 13.80	42.88	
18	1 1/8" - 18 UNEF	33.00	68.25	26.97	34.93	34.14	5.16	49.23	19.05	25.40	3.05	72.24	7.30 15.50	45.24	
20	1 1/4" - 18 UNEF	38.10	69.85	29.36	38.10	37.31	5.16	49.23	19.05	28.80	3.05	82.55	8.90 18.50	50.00	
22	1 3/8" - 18 UNEF	38.10	69.85	31.75	41.28	40.48	5.16	49.23	19.05	31.80	3.05	82.55	8.90 18.50	50.80	
24	1 1/2" - 18 UNEF	44.20	75.40	34.92	44.45	43.65	5.16	49.23	20.62	35.10	3.73	94.46	11.90 23.40	53.98	
28	1 3/4" - 18 UNS	44.20	77.00	39.67	50.80	50.01	5.16	49.23	20.62	41.00	3.73	94.46	11.90 23.40	55.58	
32	2" - 18 UNS	52.70	77.00	44.45	57.15	56.36	9.12	49.23	22.23	47.80	4.39	106.38	15.90 31.30	65.89	
36	2 1/4" - 16 UN	58.40	83.30	49.23	63.50	62.71	9.12	49.23	22.23	53.80	4.39	109.12	17.60 34.50	69.06	
40	2 1/2" - 16 UN	68.28	88.90	55.58	69.85	69.16	9.12	49.23	22.23	60.50	4.39	114.71	23.10 34.50	80.98	
44	2 3/4" - 16 UN	88.90	105.00	60.32	76.20	75.40	9.12	49.23	22.23	66.60	4.39	-	30.00 47.06	-	

Note: Dimensions are in mm.

LMJ RANGE
PRODUCT SAFETY INFORMATION

These notes are intended to be used in conjunction with the Product Catalogue and Product Specification. Products may be safely used in the applications for which they have been designed and within the specified rating and environments. If products are exposed to conditions outside the performance ratings or specified environments they may constitute a hazard. In particular it should be noted that:-

1. Material Content

Circular Connectors generally use metalwork parts made of brass, aluminium, phosphor-bronze or steel, which, dependant on the particular application, may be passivated and protected with cadmium or zinc plate – in conjunction with chromated or anodised surface finishes. The insulating materials can either be natural or synthetic rubber, together with plastic or glass-filled plastic moulded parts. Contact materials vary but are usually made of brass, phosphor-bronze, alumel or chromel.

2. Electric Shock, Burns and Fire

Hazard can occur if the product is used outside the specified parameters or if the product is damaged, wrongly wired or poorly assembled, or poorly integrated into larger equipments, or contaminated with conductive fluids. Live circuit terminations must be protected and live circuits never broken by disconnecting products.

Hot spots may be created when resistance is increased due to damage or incorrect integration particularly soldering, or loose terminations. Overheating can cause breakdown of insulation, electric shock, burns or, ultimately, fire. In the event of fire noxious and/or toxic fumes may be released and, in these circumstances, any fire involving the product should be dealt with by personnel properly equipped. Connectors with exposed terminations or contacts should not be used on the current supply side of a circuit with exposed contacts on an unmated product. Before making a circuit live, the product and wiring should be checked to ensure there is no electrically conducting debris present. Circuit resistance checks should also be conducted before making the circuit live. Always ensure that connectors are assembled and wired by properly trained personnel.

3. Use, Transport and Storage of Products

Care must be exercised to avoid damage to any part of the products during transporting, storage or use. Abnormal transit or storage conditions and abuse during installation can give rise to damage. Products should not be used in a damaged condition.

Improper storage (particularly of damaged products) can give rise to additional hazards particularly corrosion. Attention is specifically drawn to the need for proper storage of products containing cadmium and you are advised to see the Guidance Note from the Health and safety Executive on Cadmium – Health and Safety Precautions.

4. Disposal of Products

Product should not be burnt.

SAFETY RULES

1. FOLLOW THE GUIDELINES GIVEN.
2. ALWAYS PROTECT LIVE CIRCUITS AND NEVER DISCONNECT A LIVE CONNECTOR.
3. NEVER USE A DAMAGED CONNECTOR.
4. NEVER BURN DISCARDED CONNECTORS.